

Graphical rules of EMR

The different pictograms are based on dimension a (cm).

The different lines and arrows are based on thickness b (pt).

The different captions are based on police size c (pt).

In this form, $a = 0.7$ cm, $b = 1$ pt, $c = 10$ pt, police Times New Roman.

All presented pictograms are defined in the case they have maximum information (i.e. some of them can be simplified in some cases, for example no signal input for some conversion elements).

EMR colours

All colours are based on “Web X11 colours” which are used for the definition of standard colours on web pages (http://en.wikipedia.org/wiki/Web_colors).

Table 1: Code of EMR colours

Power source	Power system	System model	System control	Control strategy
--------------	--------------	--------------	----------------	------------------

Power source (environment):

- light green background: RGB = (152,251,152) = #(98,FB,98) = “PaleGreen”
- dark green border (size b pt): RGB = (0,128,0) = #(00,80,00) = “Green”

Power system (studied energetic system):

- orange background: RGB=(255,215,0) = #(FF,D7,00) = “Gold”
- red border (size b pt): RGB = (255,0,0) = #(FF,00,00) = “Red”

System model (estimation or model):

- purple background: RGB=(238,130,238) = #(EE,82,EE) = “Violet”
- dark blue border (size $b/2$ pt): RGB = (0,0,255) = #(00,00,FF) = “Blue”

System control (inversion-based control, i.e. local control level):

- light blue background: RGB (135,206,235) = #(87,CE,EB) = “SkyBlue”
- dark blue border (size $b/2$ pt): RGB = (0,0,255) = #(00,00,FF) = “Blue”

Control strategy (energy management or supervision or strategy):

- dark blue background: RGB = (0,0,255) = #(00,00,FF) = “Blue”
- dark blue border (size $b/2$ pt): RGB = (0,0,255) = #(00,00,FF) = “Blue”

Nota: all elements with a dark blue border (control, model, strategy) have to be implemented in the controller board.

Generalities on EMR pictograms

Elements

- borders of power EMR pictograms: b pt (i.e. source and power elements),
- borders of signal EMR pictograms: $b/2$ pt (i.e. control, estimations, strategy),
- green pictograms for the system environment,
- orange pictograms for the studied system,
- light blue pictograms for the (local) control,
- purple pictograms for estimation or models,
- dark blue pictograms for the control strategy,
- legend of EMR elements: dashed line ($b/2$ pt), double empty arrow (medium size), text and equation number (police c pt).

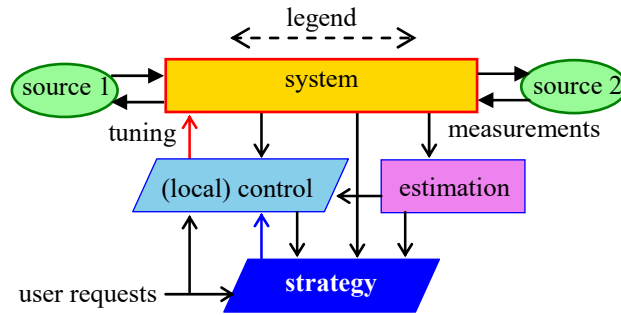

Figure 1: Principle for the description of the control of a system using EMR

Different kind of vectors

- power vector (action/reaction): straight line (b pt), full arrow (medium size), length a cm (not mandatory), space between action and reaction arrows $a/2$ cm,
- signal vector (tuning, control): straight line ($b/2$ pt), empty arrow (small size),
- all vectors are drawn by black arrows except the following vectors,
- red arrows for signal inputs which have been chosen to tune the system,
- dark blue arrows for signal vector which delivers a criteria to the local control (delivered by the control strategy)
- sensor: oval pictogram ($a/2$ cm, $a/4$ cm), dark border ($b/2$ pt), transparent background

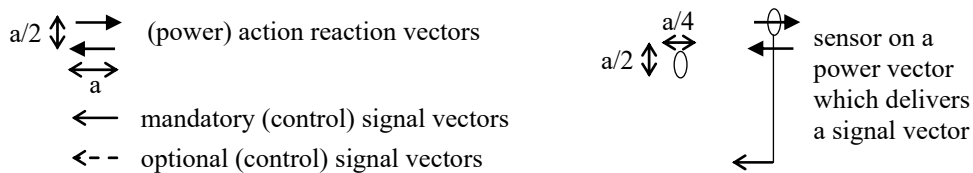

Figure 2: Graphical rules for power variables, signal variables and sensors

EMR pictograms for power elements

Energy source element

- oval pictogram: small diameter a , large diameter $2a$,
- light green background, dark green border (b pt),
- name in the pictogram, bold, black color, c pt,
- signal input not mandatory

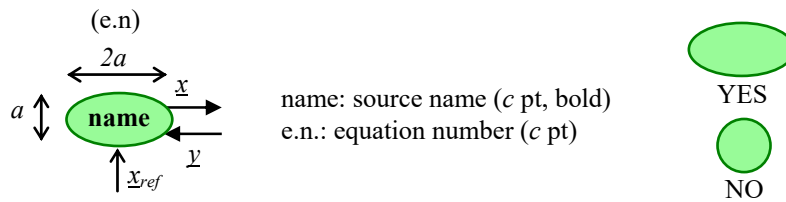

Figure 3: Graphical description of the pictogram of the energy source element

Accumulation element

- crossed rectangle pictogram: height a , width $a/2$,
- internal bar: slash = / (not anti-slash = \),
- orange background, red border (b pt).

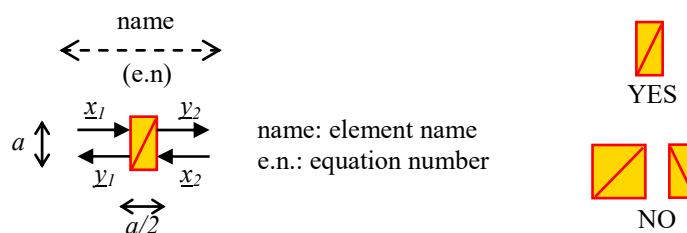

Figure 4: Graphical description of the pictogram of the accumulation element

Conversion element

- square pictogram (mono-physical): width a ,
- circular pictogram (multi-physical): diameter a ,
- orange background, red border (b pt),
- signal input not mandatory.

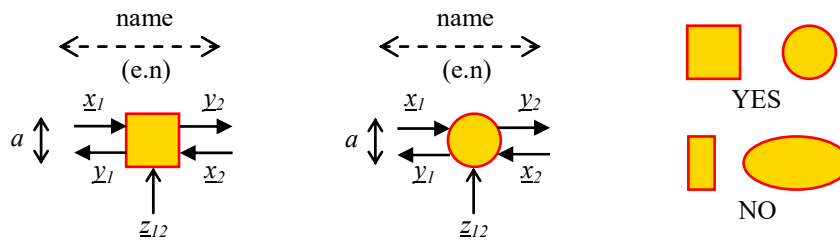

Figure 5: Graphical description of the pictograms of the conversion element

Coupling element

- overlapped square pictograms (mono-physical): width a ,
- overlapped circular pictogram (multi-physical): diameter a ,
- overlapped section based on $a/3$
- $(m-1)$ overlapped pictograms for m connected elements
- orange background, red border (b pt).

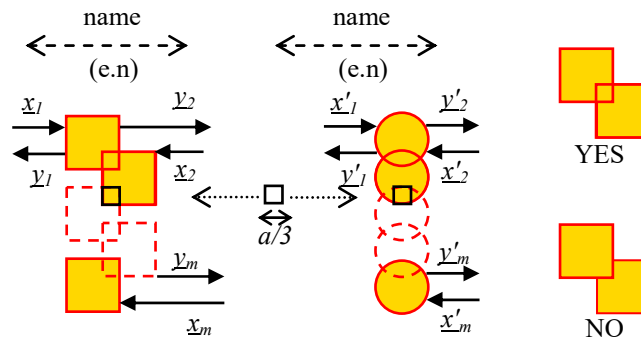

Figure 6: Graphical description of the pictograms of the coupling element

Switching element

- non-overlapped rectangular pictograms: height a , width $a/2$,
- n rectangular pictograms for n connected parts ($n-1$ models),
- orange background, red border (b pt),
- no name (operator and not physical element),
- no equation (same inputs and outputs for any connected element),
- number of the model, black, c pt..

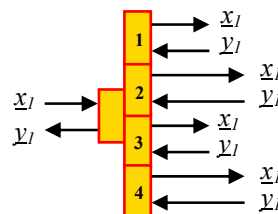

Figure 7: Graphical description of the pictogram of the switching element

Amplification elements

- square pictograms: width a ,
- “>” (greater than) or “<” (lower than) inside the square,
- orange background, red border (b pt),
- no name (operator and not physical element).

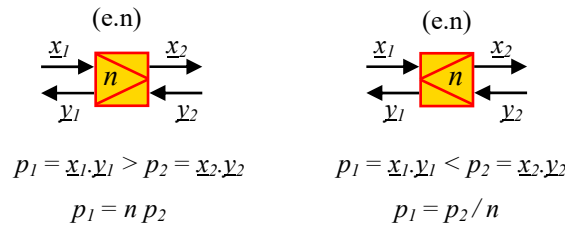

Figure 8: Graphical description of the pictogram of the adaptation element

EMR pictograms for control elements

All control elements are described by the same shape (parallelogram), the same colours (light blue background and dark blue border with thickness $b/2$ pt). They are connected by signal arrows ($b/2$ thickness, small empty arrow)

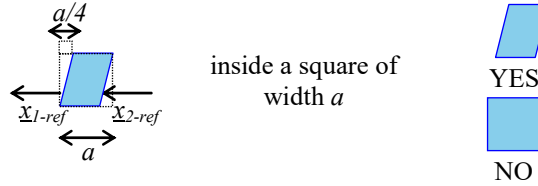

Figure 9: Graphical description of the pictogram of control elements

Inversion of a conversion element

- parallelogram pictogram: width a , height a ,
- light blue background, dark blue border ($b/2$ pt),
- signal arrows: $b/2$ thickness, small empty arrow,
- no name, equation under the pictogram (c pt),
- measurement signal bot mandatory.

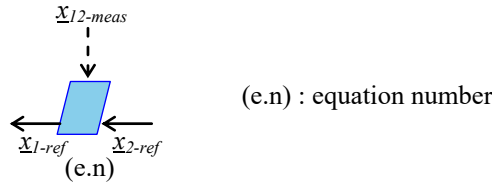

Figure 10: Graphical description of the pictogram of conversion element inversion

Inversion of an accumulation element

- parallelogram pictogram: width a , height a ,
- internal bar: anti-slash = \ (not slash = /),
- light blue background, dark blue border ($b/2$ pt),
- no name, equation under the pictogram (c pt),
- measurement signal not mandatory.

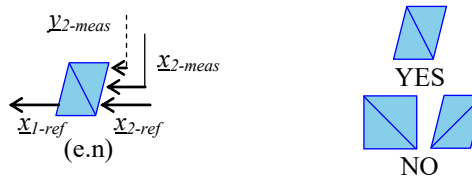

Figure 11: Graphical description of the pictogram of accumulation element inversion

Inversion of a coupling element

- overlapped parallelogram pictogram: width a , height a ,
- $(m-1)$ overlapped pictograms for m connected elements
- overlapped section based on $a/3$
- light blue background, dark blue border ($b/2$ pt),
- dark blue criteria arrow (thickness $b/2$, small empty arrow).

Nota: there are different types of inversion of coupling elements from their functionality (disturbance, neutral, composition and decomposition coupling); if the graphical rules are the same, the number of I/Os will be different.

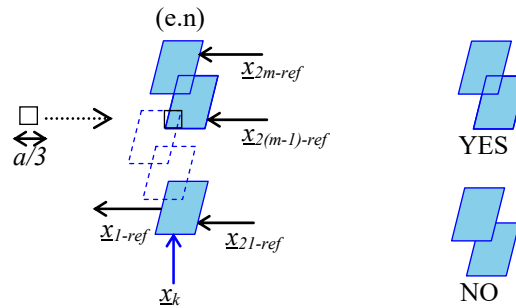

Figure 12: Graphical description of the pictogram of coupling element inversion

Inversion of a switching element

- non-overlapped parallelogram pictograms: height a , width a ,
- n rectangular pictograms for n connected parts ($n-1$ models)
- light blue background, dark blue border ($b/2$ pt).

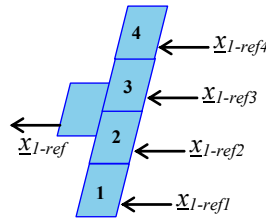
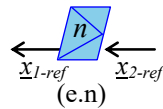

Figure 13: Graphical description of the pictogram of the switching element inversion

Amplification elements

- parallelogram pictograms: height a , width a ,
- “>” (greater than) or “<” (lower than) inside the square
- light blue background, dark blue border ($b/2$ pt).



$$p_1 = n p_2 > p_2$$

Figure 14: Graphical description of the pictogram of the adaptation element inversion

Control strategy

- parallelogram pictograms: height a , width $3a$,
- dark blue background, dark blue border ($b/2$ pt).
- “strategy” written in white (c pt, bold) inside,
- the number of signal I/Os depends on the strategy.

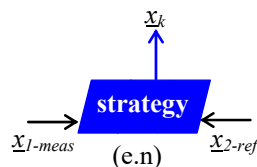

Figure 15: Graphical description of the pictogram of the control strategy

Estimation elements

The estimation elements have the same shapes than power elements (source and system), but different colours:

- purple background, dark blue border ($b/2$ pt).
- signal arrows: $b/2$ thickness, empty arrow,
- no name, equation above the pictogram (c pt).

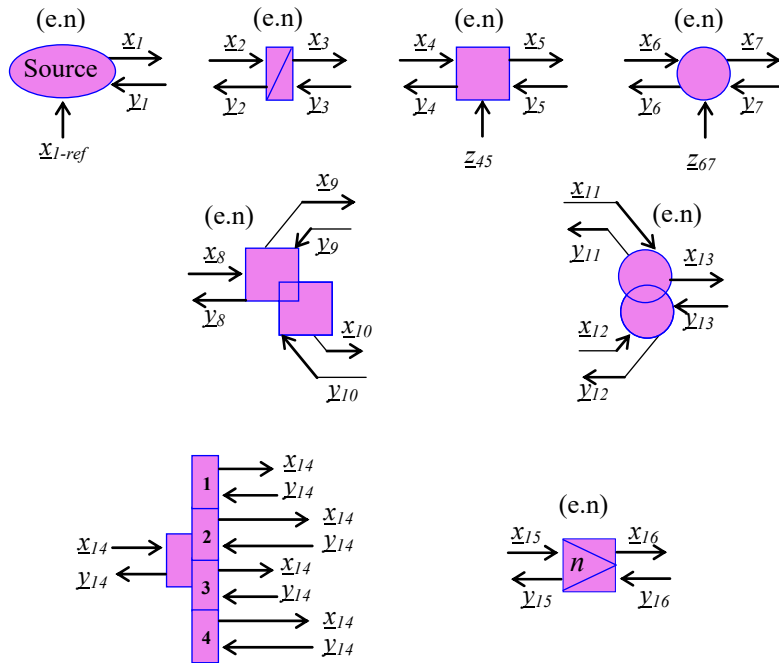

Figure 16: Graphical description of the pictogram of estimation element

Action, tuning and control paths

All these paths connect the different vectors using signal arrows (b/2 thickness, empty small arrow). It is strongly recommended to follow the EMR shapes.

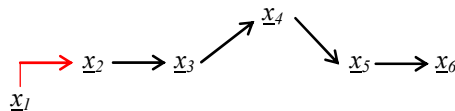

Figure 17: Graphical description of a tuning path

Example of the EMR of an entire system

The control of the traction system of an electric vehicle is given as an example including different pictograms.

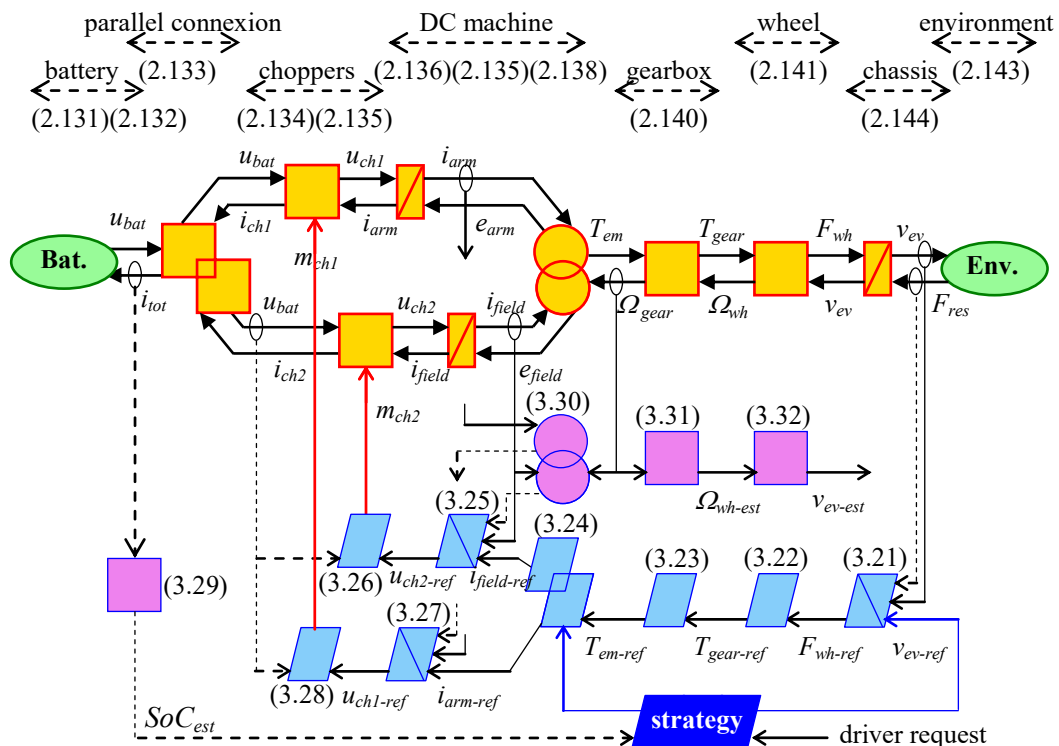

Figure 18: Example of the control of an Electric Vehicle